

FGJ(DIN-ANSI-JIS)  
 PN16-25-40(DN50)  
 /mm/

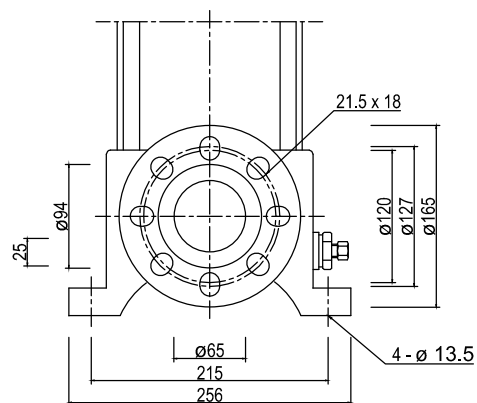

CVE 20-7

PUMPS	07.07.2020
Textilná 3/A	
040 12 Košice	

