

FGJ(DIN-ANSI-JIS)
 PN16-25-40(DN50)
 /mm/

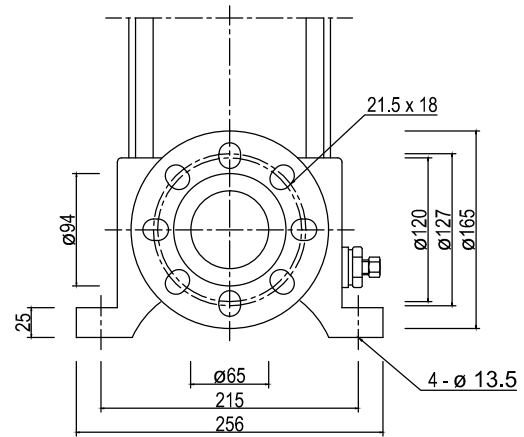

BV 15-1

PUMPS	07.07.2020
Textilná 3/A	
040 12 Košice	

